

# MİMARİ KATALOG

## ARCHITECTURAL CATALOGUE

Aluminyum Kapı Pencere ve Giydirme Cephe Sistemleri  
Aluminium Window Doors and Facade Systems



Rescara Sistem  
Profil Detayları

Rescara System  
Profile Details

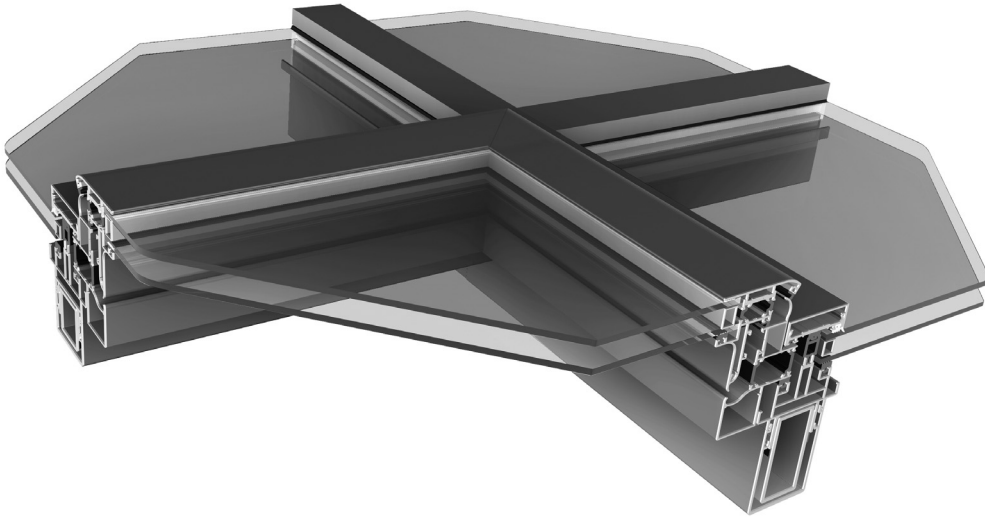

# SKKY 65

# RESCARA SİSTEM

## RESCARA SYSTEM

Aluminyum Kapı Pencere ve Giydirme Cephe Sistemleri  
Aluminium Window Doors and Facade Systems

31



32

33

34

35

36

37

38



KOD / CODE	AĞIRLIK (kg/m) / WEIGHT	Jxx cm4	Jyy cm4	L m
R50 M 16	1,971	40,203	21,856	6
R50 T 11	2,085	44,694	22,469	6

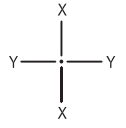

R50 M 16

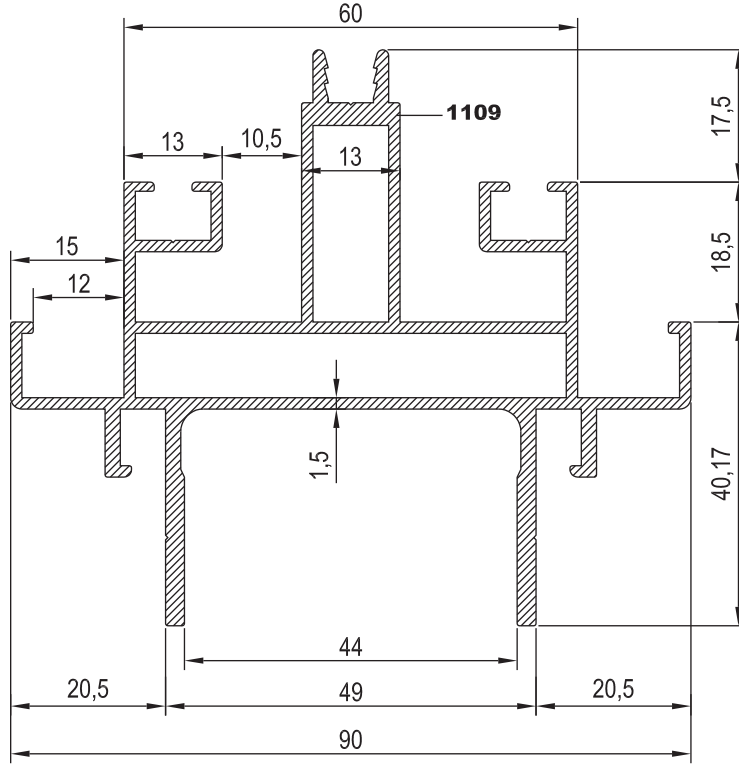

R50 T 11

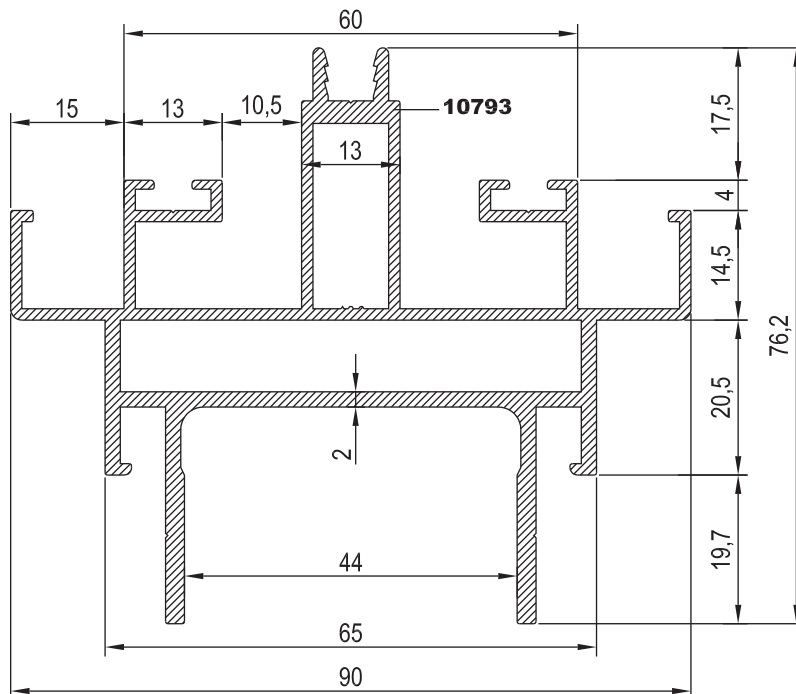

31

32

33

34

35

36

37

38



KOD / CODE	AĞIRLIK (kg/m) / WEIGHT	Jxx cm4	Jyy cm4	L m
R50 T 10	2,076	47,190	25,938	6
R50 T 09	1,101	25,071	3,889	6

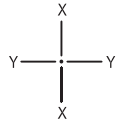

31

32

R50 T 10

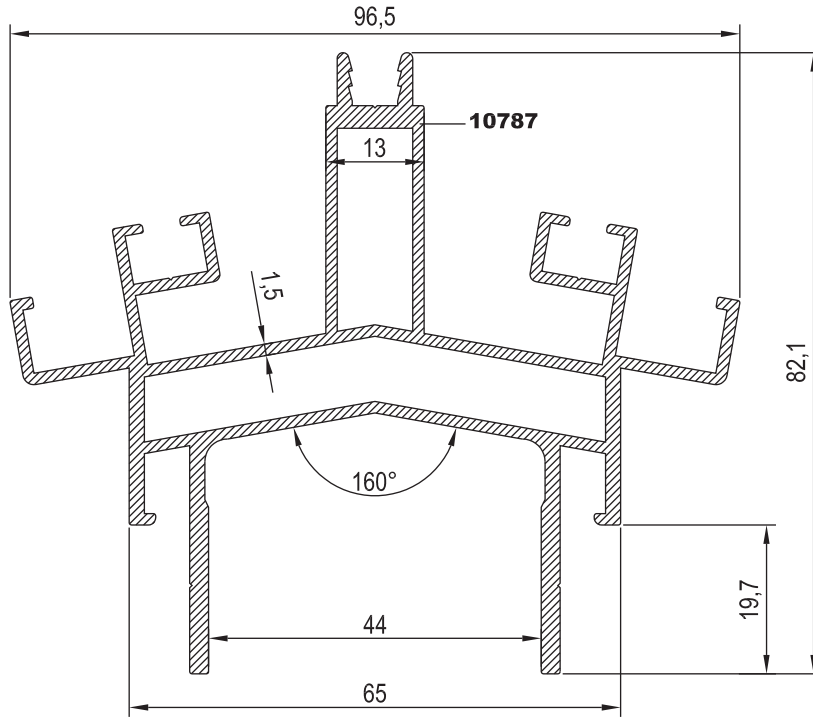

33

34

35

36

R50 T 09

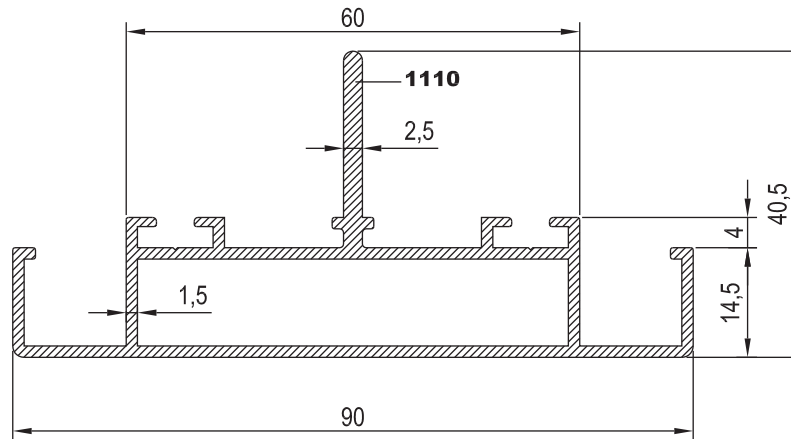

37

38



KOD / CODE	AĞIRLIK (kg/m) / WEIGHT	J <sub>xx</sub> cm <sup>4</sup>	J <sub>yy</sub> cm <sup>4</sup>	L m
R50 M 10	2,565	21,713	86,773	6
R50 T 07	1,052	9,560	4,362	6

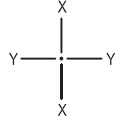

31

32

33

34

35

36

37

38

R50 M 10

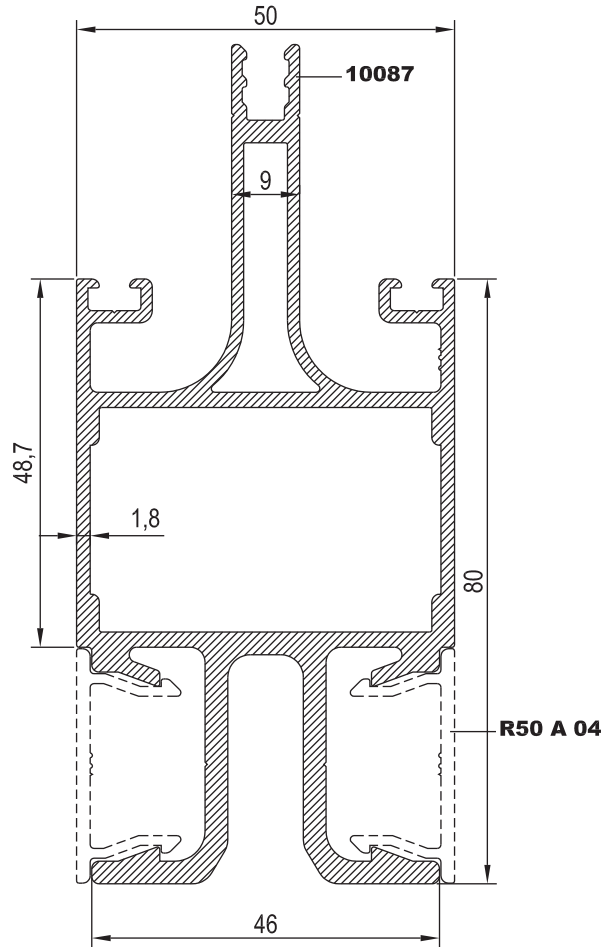

R50 T 07

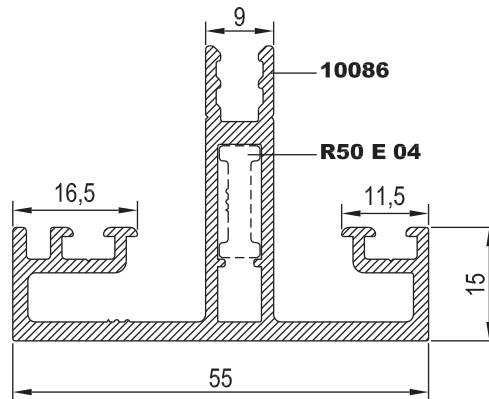



KOD / CODE	AĞIRLIK (kg/m) / WEIGHT	L m	
R50 P 33	2,996	6	
K50 P 18	2,313	6	

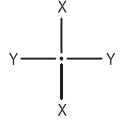

31

32

33

34

35

36

37

38

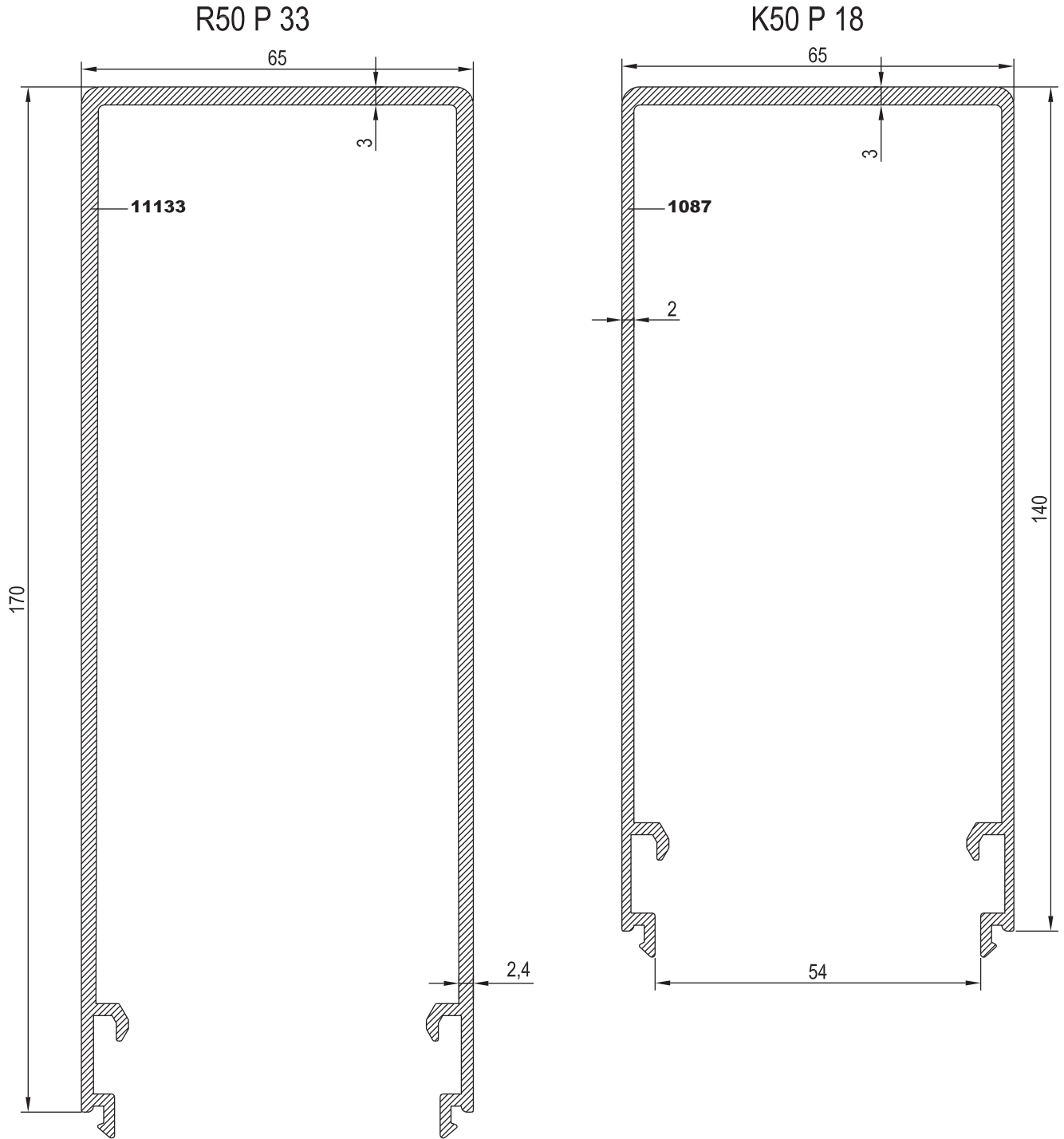



KOD / CODE	AĞIRLIK (kg/m) / WEIGHT	L m	
K50 P 19	1,337	6	
K50 P 20	0,901	6	

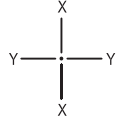

31

32

33

34

35

36

37

38

K50 P 19

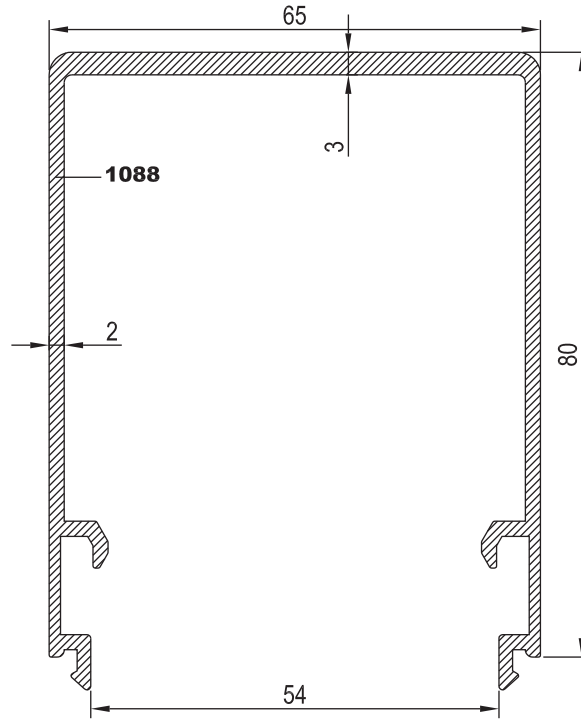

K50 P 20

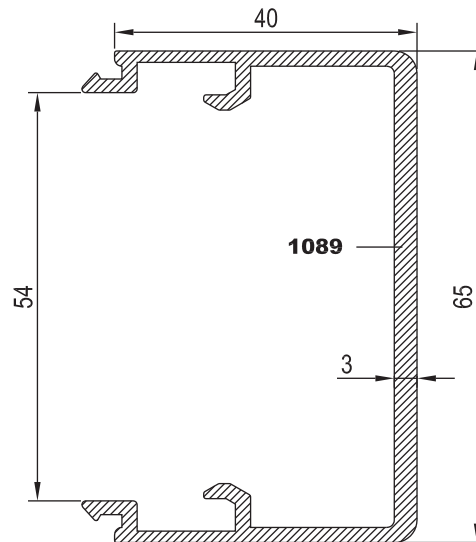



KOD / CODE	AĞIRLIK (kg/m) / WEIGHT	L m	
R50 P 05	0,566	6	
R50 P 04	0,455	6	
R50 P 21	0,872	6	
R50 P 22	0,580	6	
R50 A 04	0,245	6	
R50 E 04	0,146	6	

R50 P 05

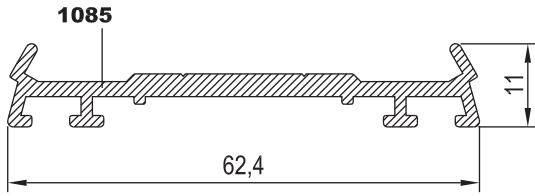

R50 P 04

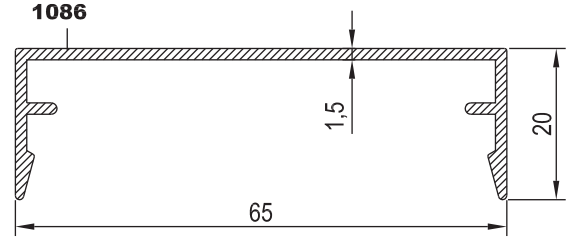

R50 P 21

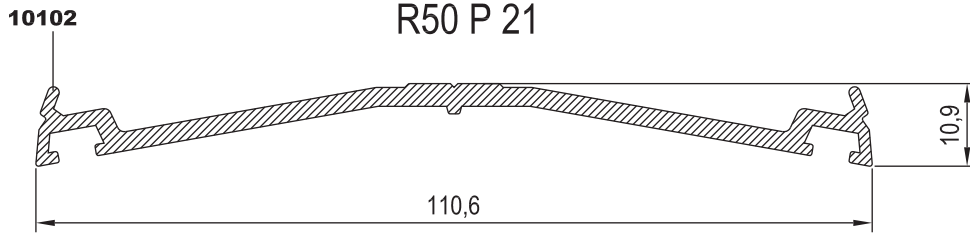

R50 P 22

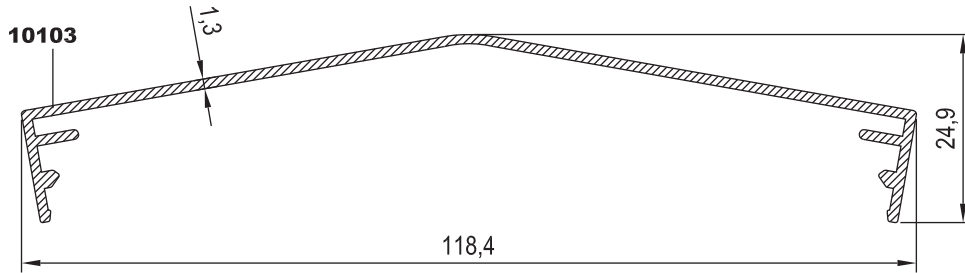

R50 A 04

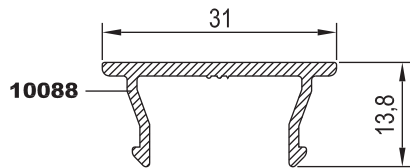

R50 E 04

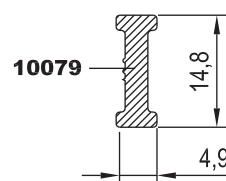





KOD / CODE	AĞIRLIK (kg/m) / WEIGHT	L m	
R50 M 22	1,730	6	
R50 M 23	1,675	6	

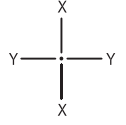

R50 M 22

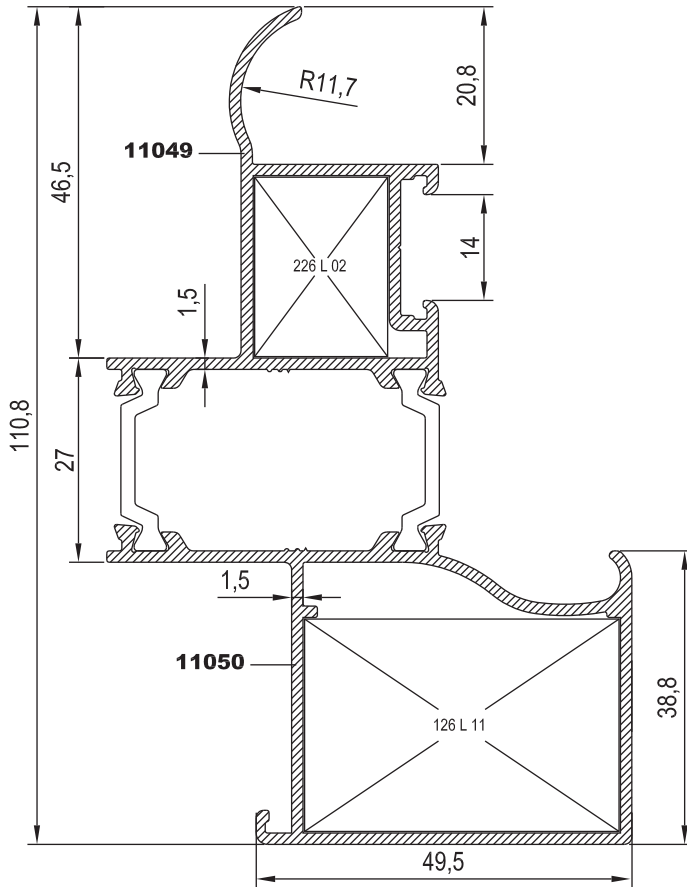

R50 M 23

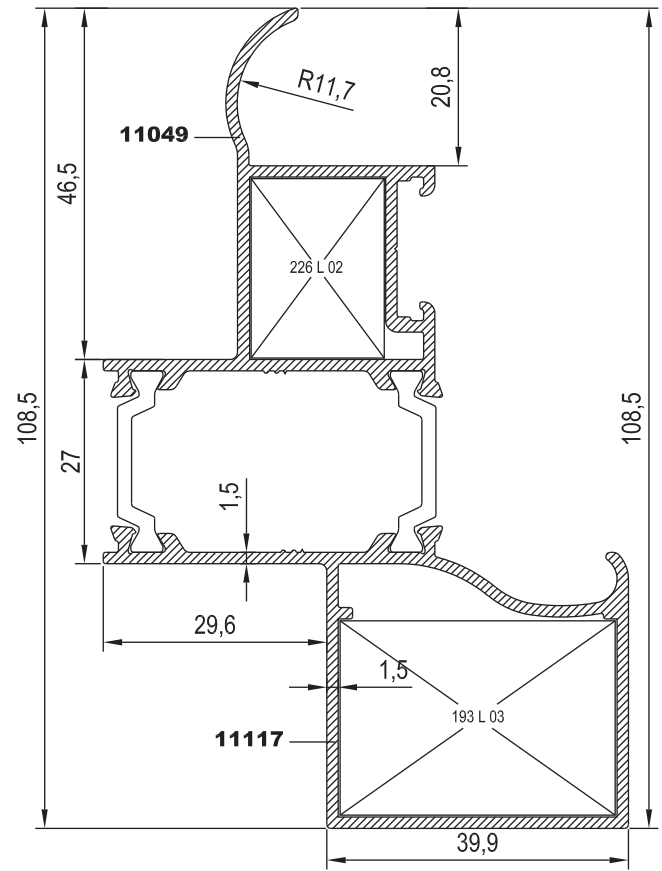

Nr

KÖŞE BAĞLANTI PROFİLİ  
PROFİL KOD NUMARASIKÖŞE BAĞLANTI PROFİLİ  
PARÇA KOD NUMARASIKESİM  
ÖLÇÜSÜ

R50 M 22	11049	2020 (25 L 02)		226 L 02		23,8 mm
	11050	2126 (25 L 11)		126 L 11		28,1 mm
R50 M 23	11049	2020 (25 L 02)		226 L 02		23,8 mm
	11117	2021 (25 L 03)		193 L 03		25,9 mm



KOD / CODE	AĞIRLIK (kg/m) / WEIGHT	L m	
R50 V 20	1,238	6	
R50 R 12	0,643	6	

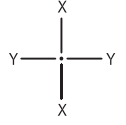

## R50 V 20

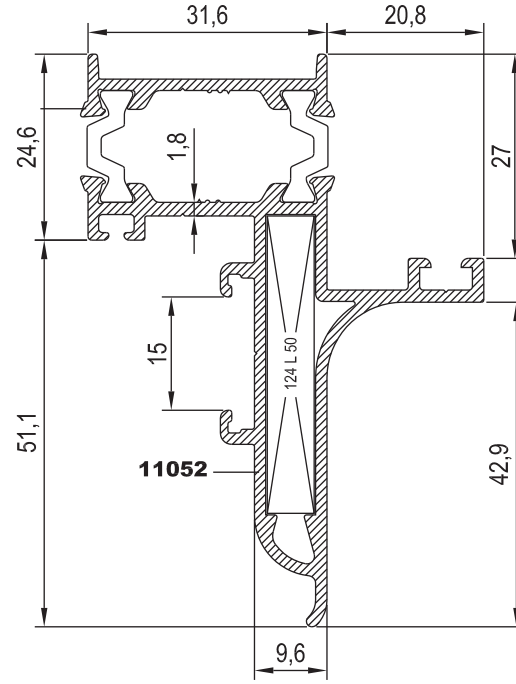

## R50 R 12

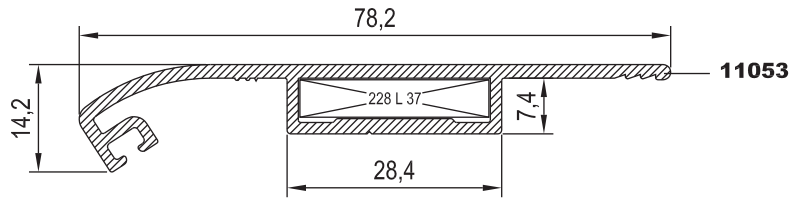

Nr

KÖŞE BAĞLANTI PROFİLİ  
PROFİL KOD NUMARASIKÖŞE BAĞLANTI PROFİLİ  
PARÇA KOD NUMARASIKESİM  
ÖLÇÜSÜ

R50 V 20	11052	10838 (25 L 50)		124 L 50		39,3 mm
R50 R 12	11053	2398 (25 L 37)		228 L 37		5,1 mm



## TAKOZLAR (CLEATS)

PROFİL KODU (PROFILE CODE)	25 L 02	25 L 03	25 L 11	25 L 37
FABRİKA KODU (FACTORY CODE)	2020	2021	2126	2398
AĞIRLIK (WEIGHT)	4,943 kg/m	4,315 kg/m	6,733 kg/m	7,971 kg/m
ÇİZİM (DRAWING)				

PROFİL KODU (PROFILE CODE)	25 L 50			
FABRİKA KODU (FACTORY CODE)	10838			
AĞIRLIK (WEIGHT)	1,748 kg/m			
ÇİZİM (DRAWING)				

Nr			KESİM ÖLÇÜSÜ CUTTING SIZE		AKS. KODU ACS. CODE
R50 M 22	11049	25 L 02 (2020)	23,8 mm	226 L 02	
	11050	25 L 11 (2126)	28,1 mm	126 L 11	
R50 M 23	11049	25 L 02 (2020)	23,8 mm	226 L 02	
	11117	25 L 03 (2021)	25,9 mm	193 L 03	
R50 V 20	11052	25 L 50 (10838)	39,3 mm	124 L 50	
R50 R 12	11053	25 L 37 (2398)	5,1 mm	228 L 37	



31

32

33

34

35

36

37

38

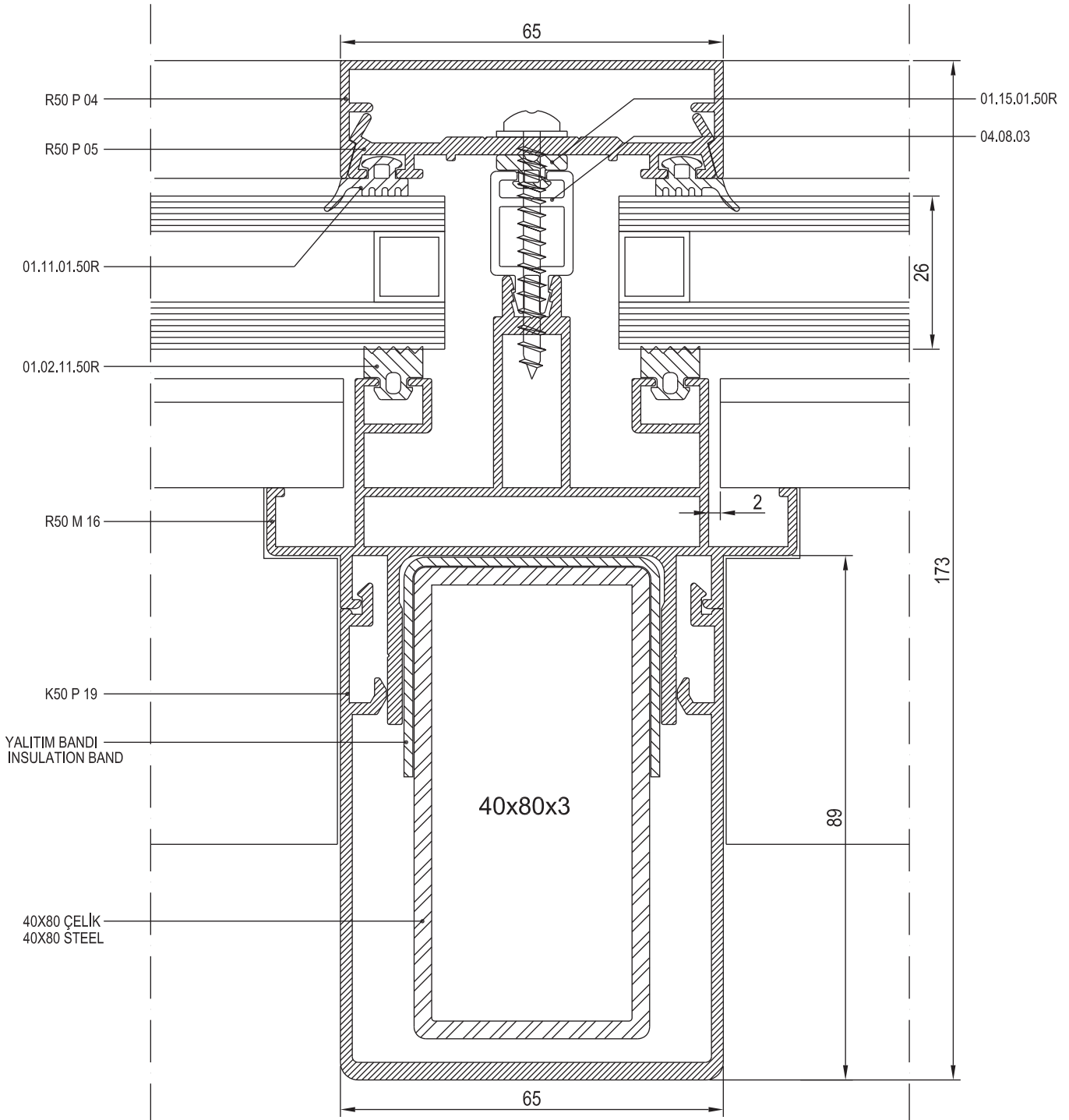
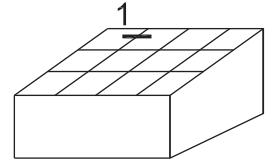

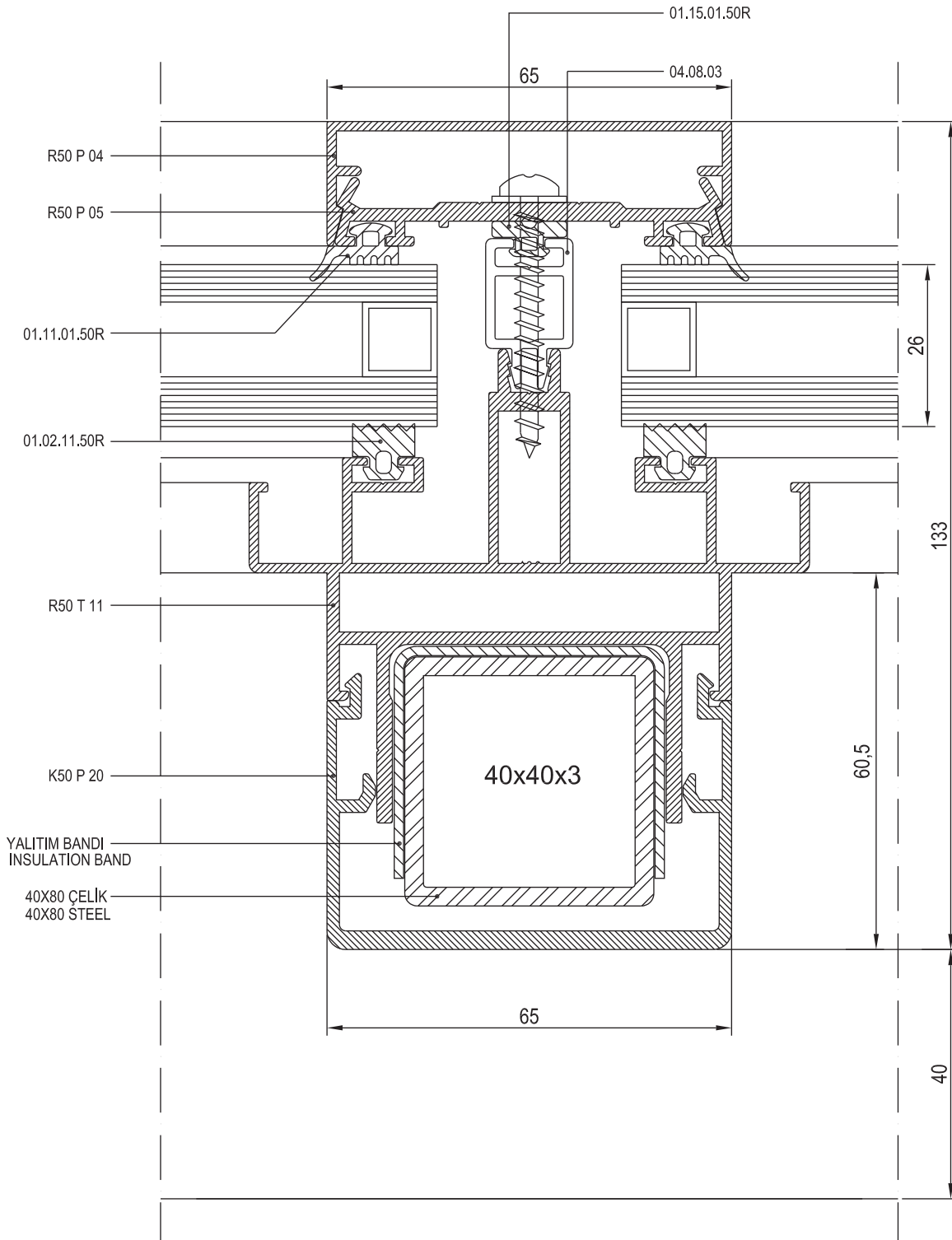
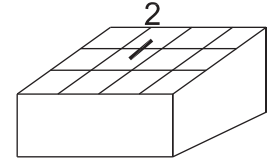

31

32

33

34

35

36

37

38



31

32

33

34

35

36

37

38

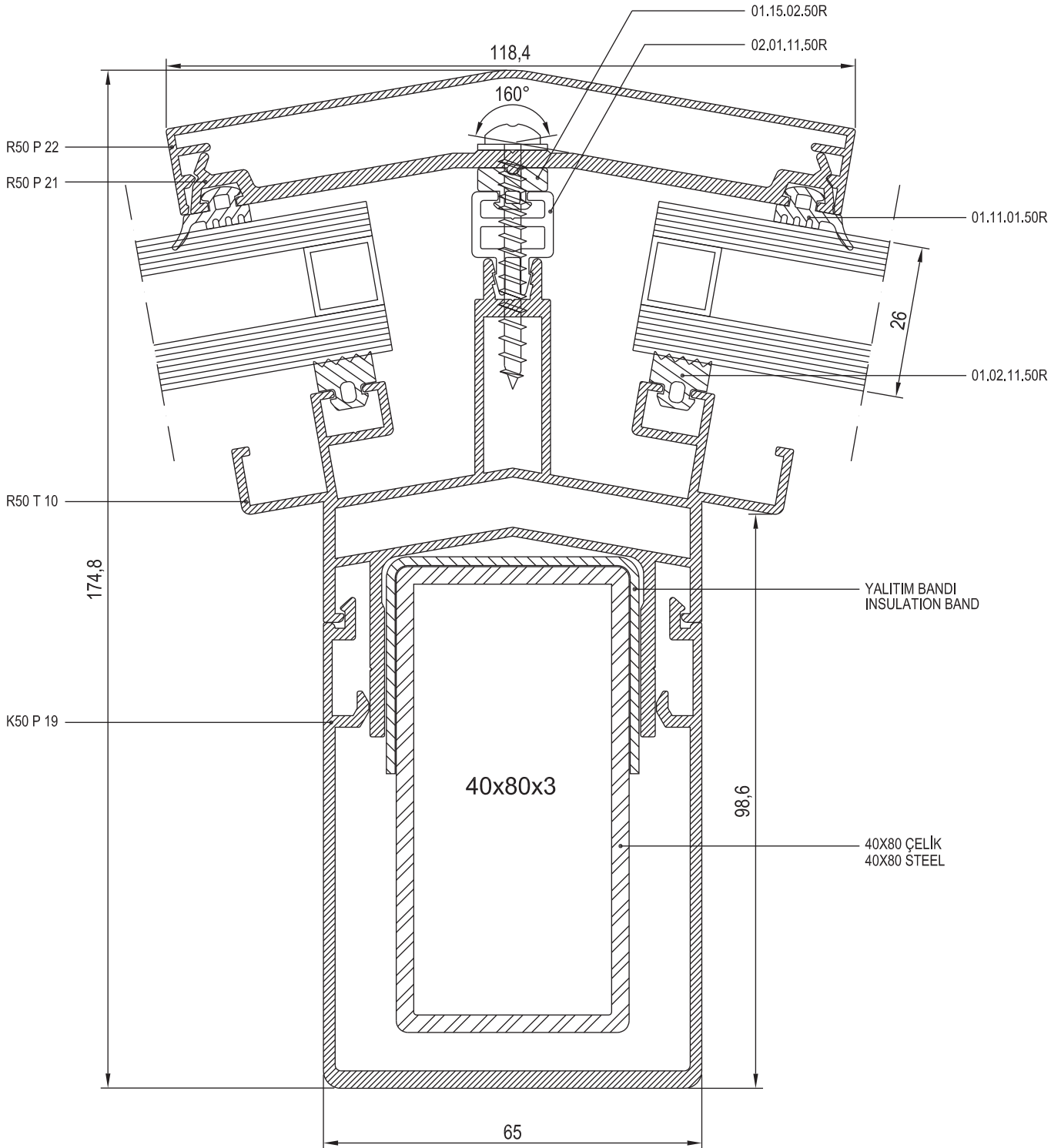
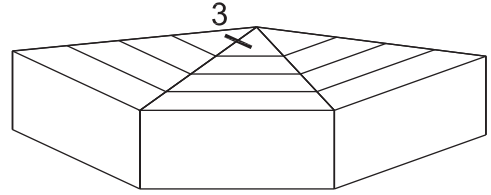

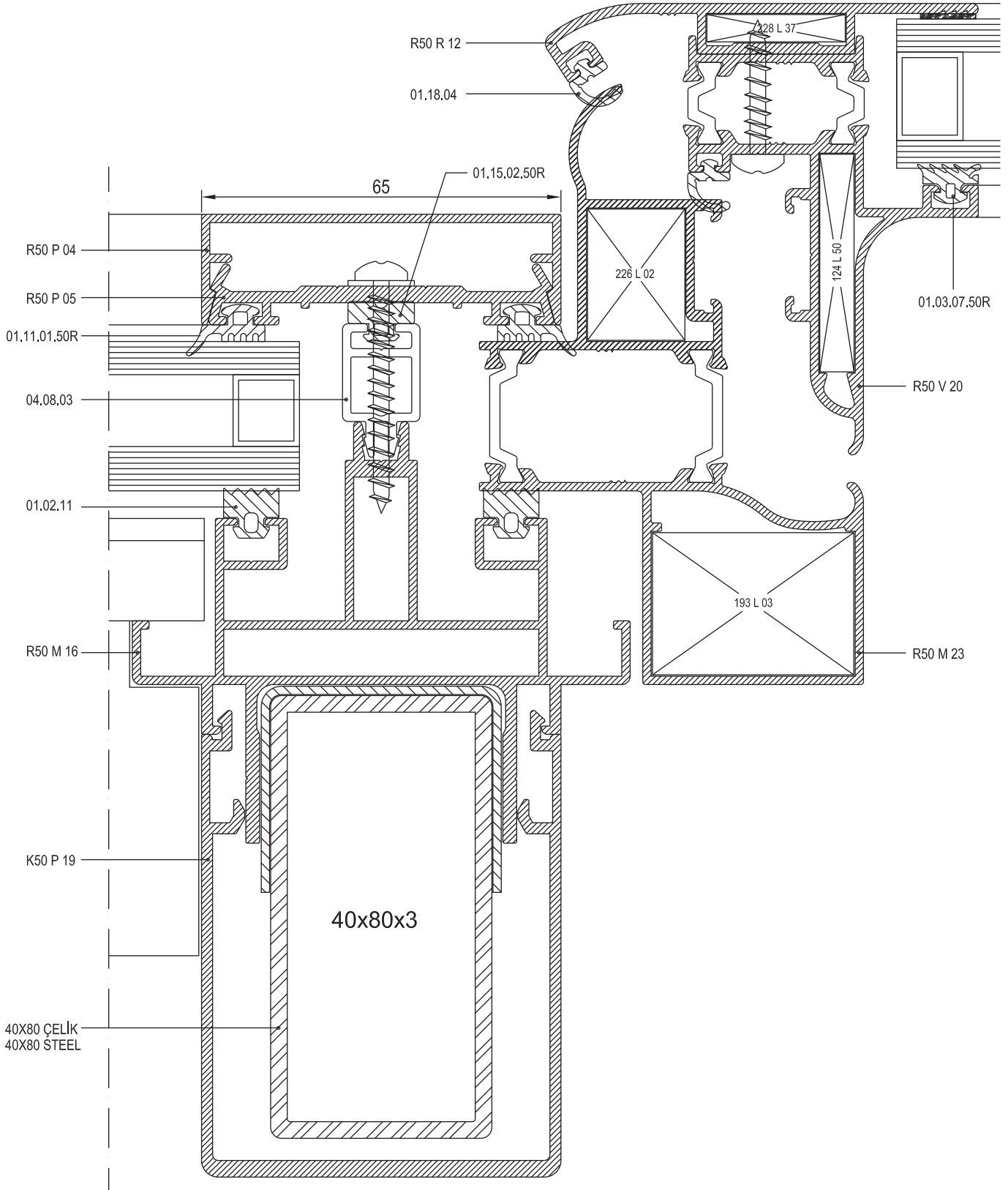
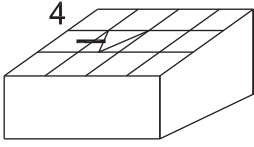

31

32

33

34

35

36

37

38



31

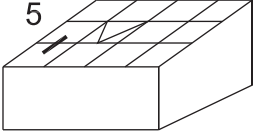

32

33

34

35

36

37

38

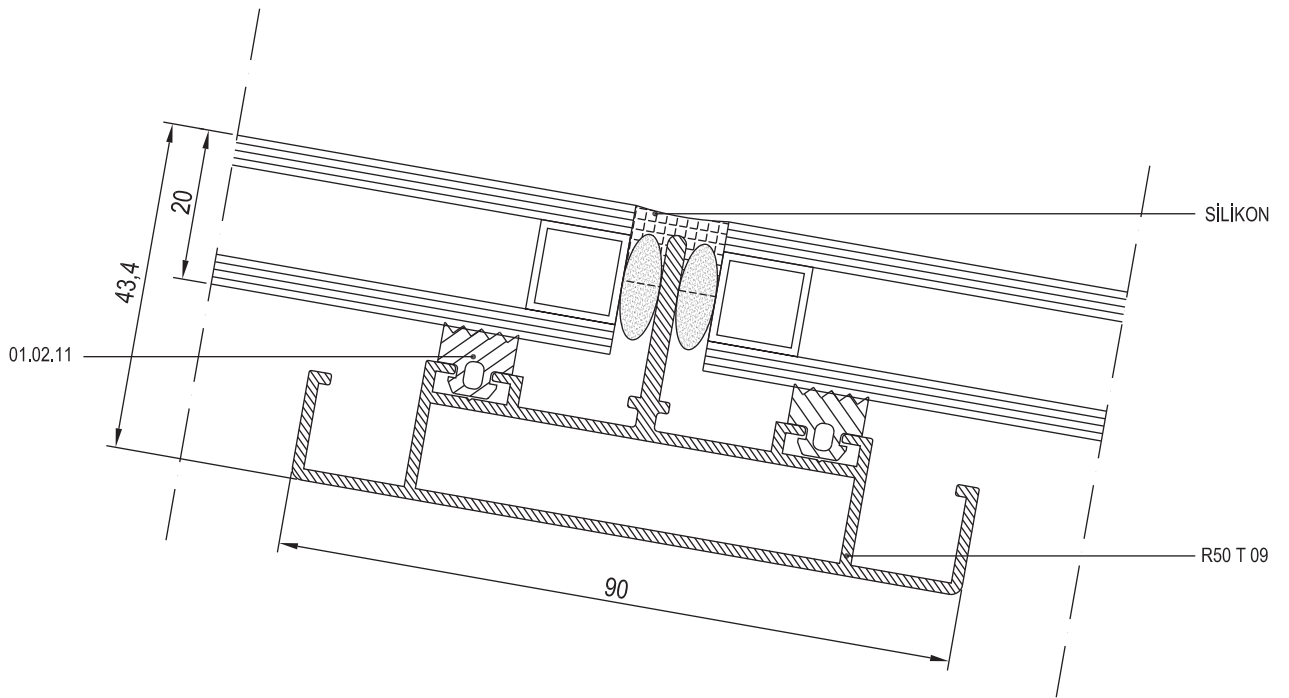



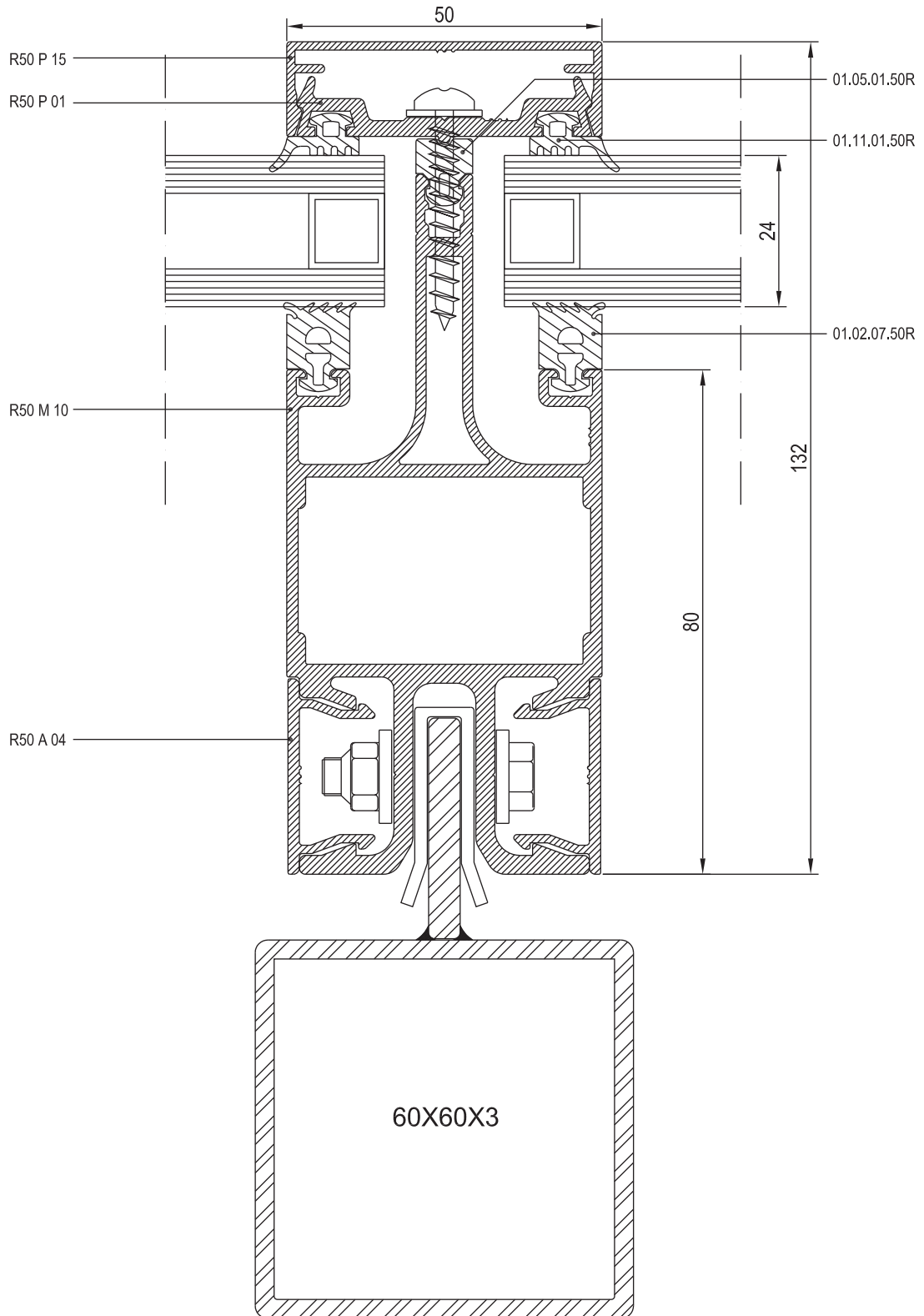
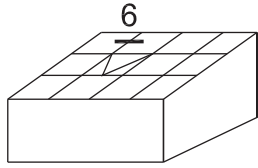

31

32

33

34

35

36

37

38



31

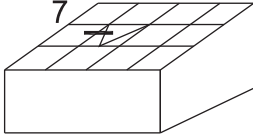

32

33

34

35

36

37

38

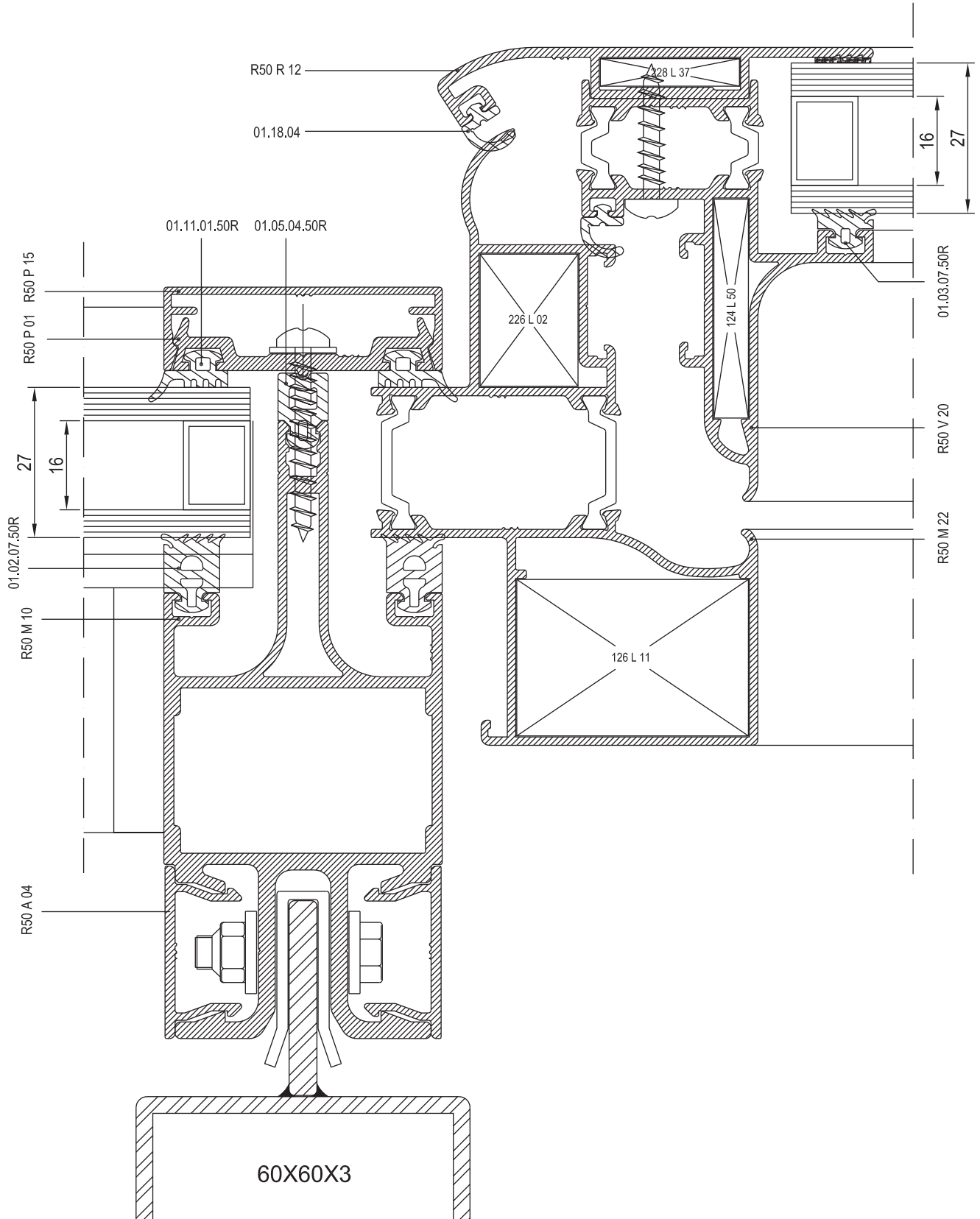

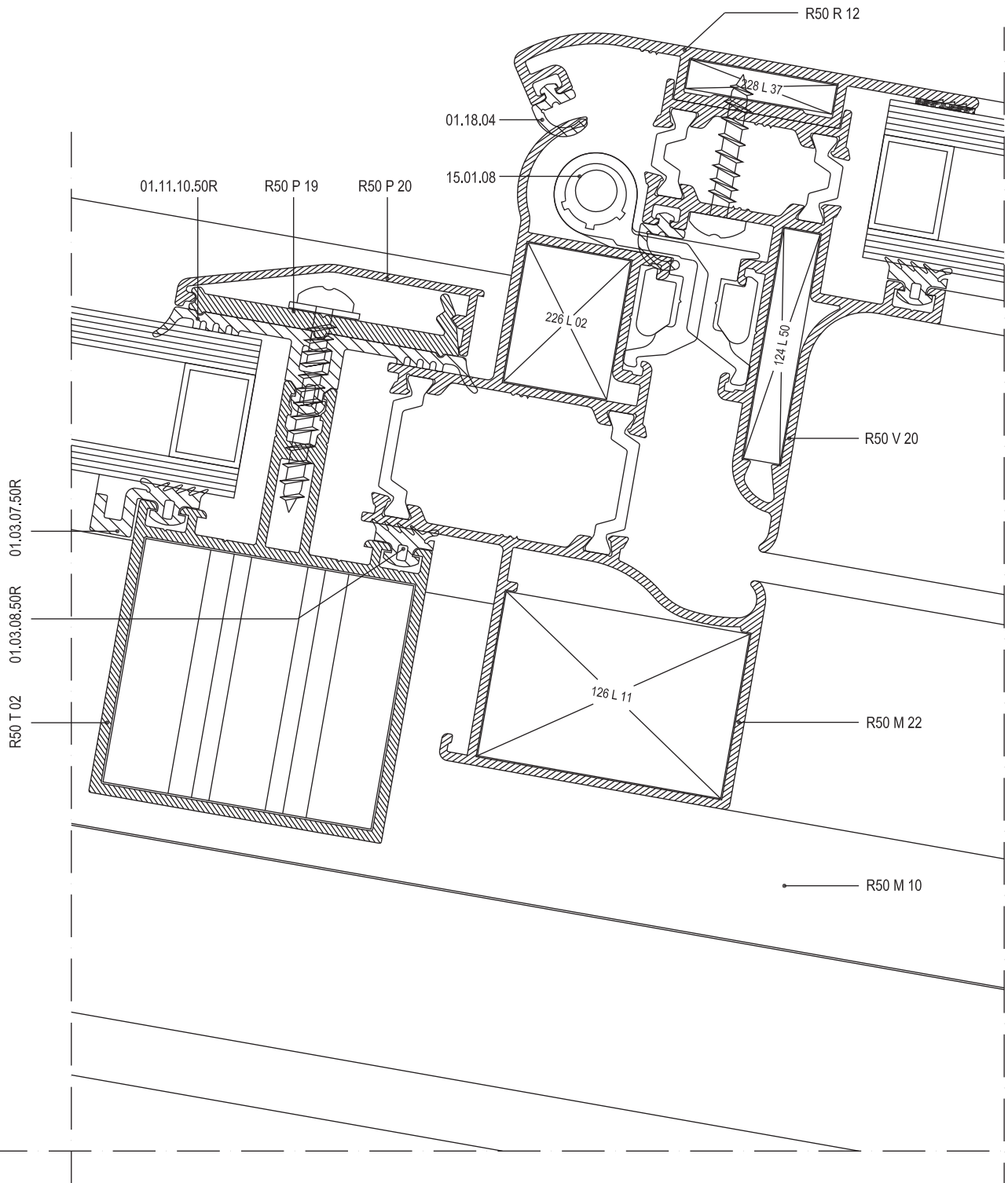
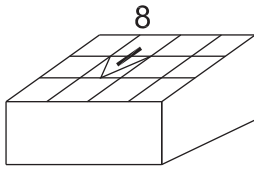

31

32

33

34

35

36

37

38



31

32

33

34

35

36

37

38

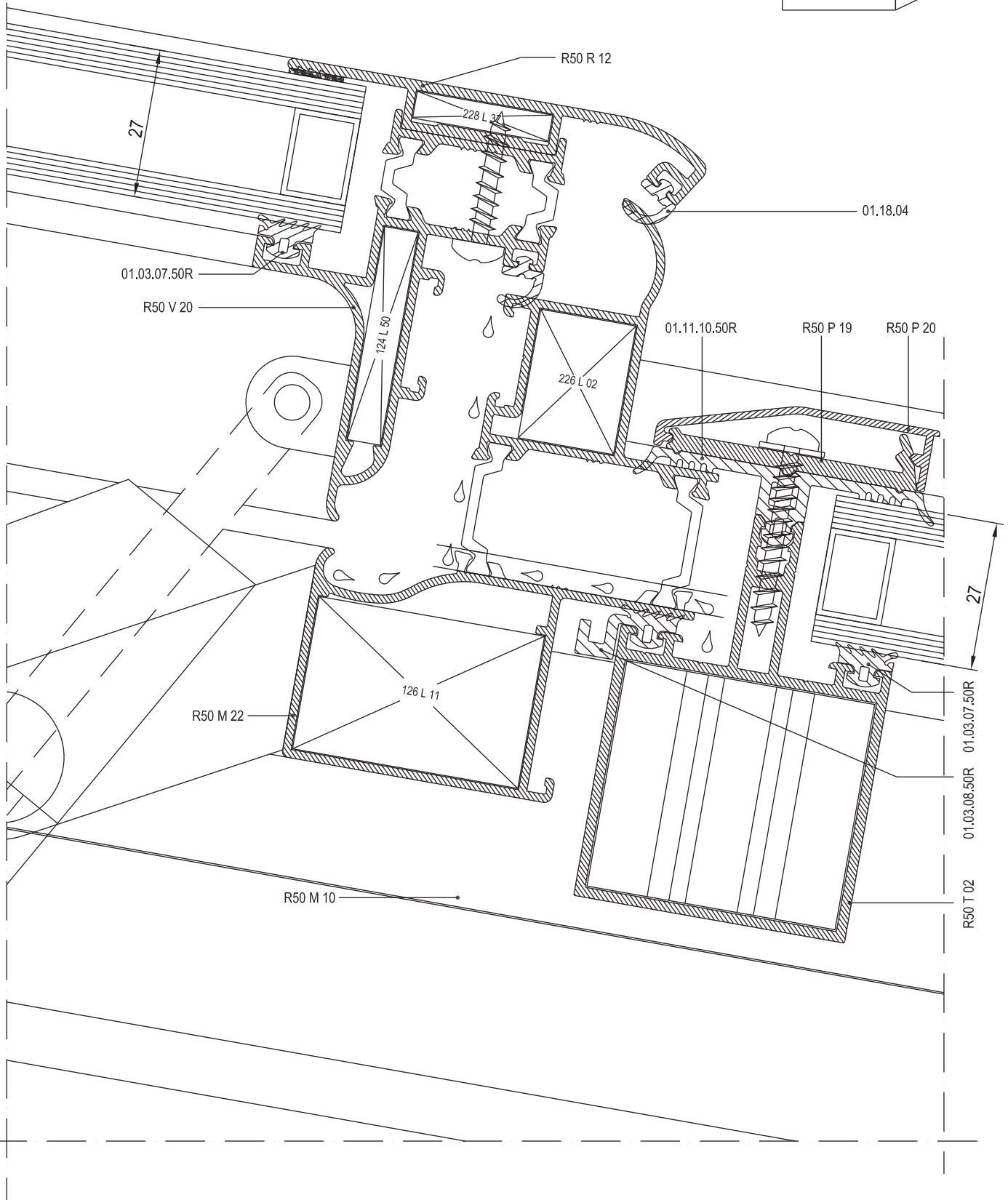
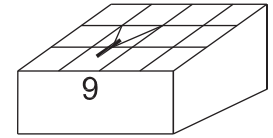

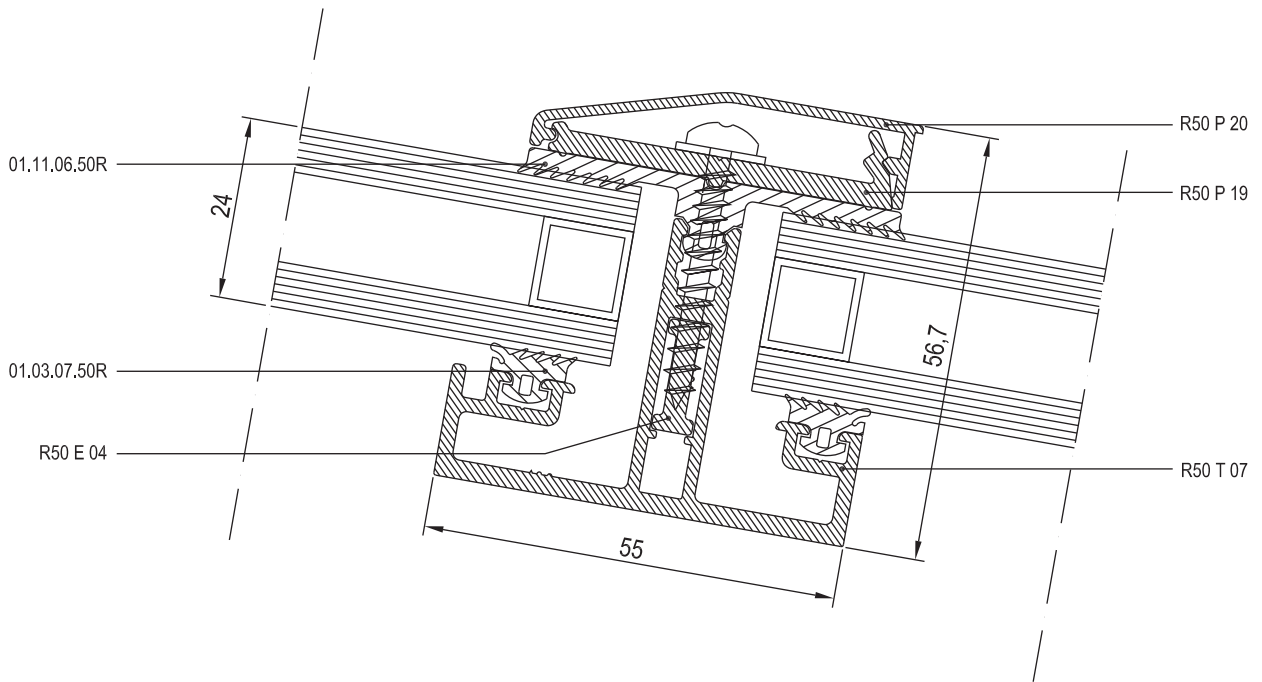
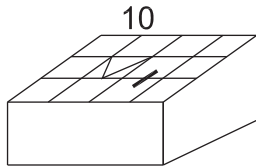

31

32

33

34

35

36

37

38



31

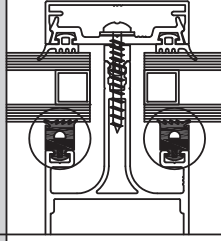

01.02.07.50R

CAM FİTİLİ  
GLAZING GASKET  
EPDM  
130 gr/m

01.11.06.50R

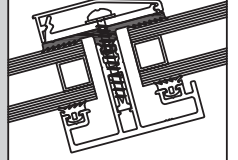
KAPAK ALTI FİTİLİ  
OUTSIDE GASKET  
EPDM  
242 gr/m

32

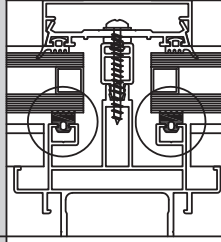

01.02.11.50R

CAM FİTİLİ  
GLAZING GASKET  
EPDM  
77 gr/m

01.11.10.50R

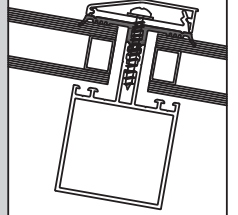
KAPAK ALTI FİTİLİ  
OUTSIDE GASKET  
EPDM  
230 gr/m

33

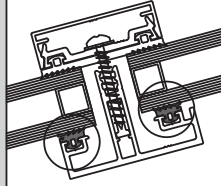

01.03.07.50R

CAM FİTİLİ  
GLAZING GASKET  
EPDM  
60 gr/m

01.15.01.50R

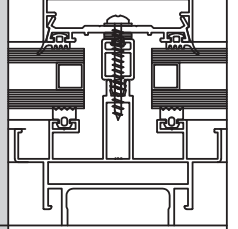
ORTA FİTİLİ  
CENTRAL GASKET  
EPDM  
52 gr/m

34

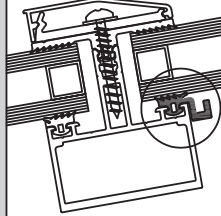

01.03.08.50R

CAM FİTİLİ  
GLAZING GASKET  
EPDM  
100 gr/m

01.15.02.50R

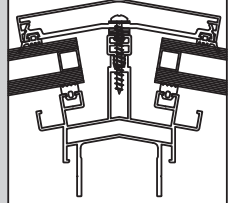
ORTA FİTİLİ  
CENTRAL GASKET  
EPDM  
74 gr/m

35

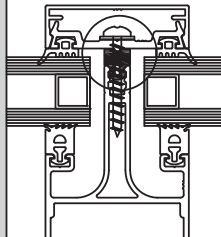

01.05.01.50R

ORTA BASKI FİTİLİ  
CENTRAL GASKET  
EPDM  
80 gr/m

02.01.11.50R

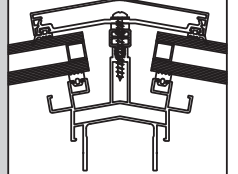
PVC PROFİL  
PVC PROFILE

37

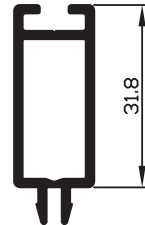
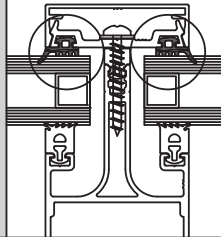

01.11.01.50R

DIŞ CAM FİTİLİ  
GLAZING GASKET (OUT)  
EPDM  
60 gr/m

02.01.12.50R

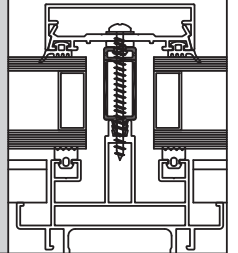
PVC PROFİL  
PVC PROFILE

38

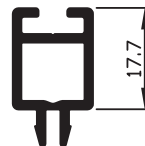
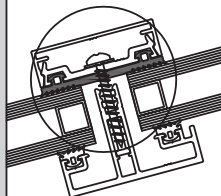

01.11.05.50R

KAPAK ALTI FİTİLİ  
OUTSIDE GASKET  
EPDM  
224 gr/m

04.08.03

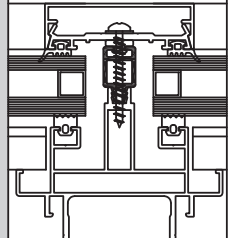
PVC PROFİL  
PVC PROFILE

# RESCARA SİSTEM

## RESCARA SYSTEM

Aluminyum Kapı Pencere ve Giydirmce Cephe Sistemleri  
Aluminium Window Doors and Facade Systems



31

32

33

34

35

36

37

38

# RESCARA SİSTEM

## RESCARA SYSTEM

Aluminyum Kapı Pencere ve Giydirme Cephe Sistemleri  
Aluminium Window Doors and Facade Systems

31



32

33

34

35

36

37

38